

3 SOFA  kg  1.13m³

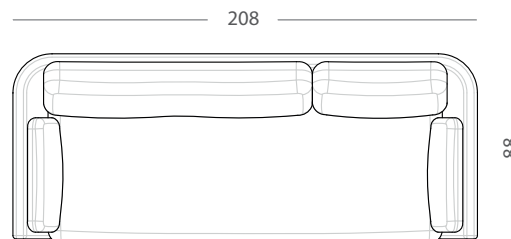

2 SOFA  kg  0.89m³

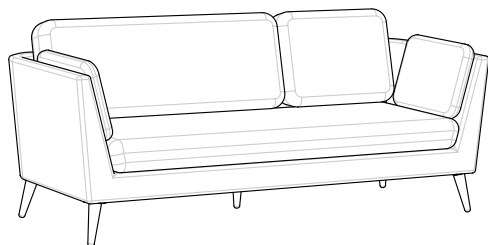
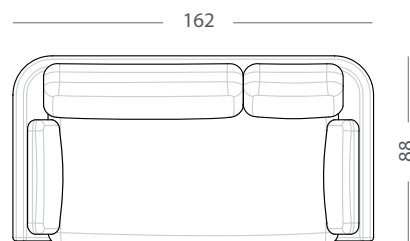
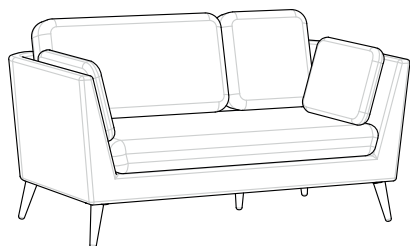

3 SOFA
Design Agnieszka Kasprzak

FOTEL  kg  0.49m³

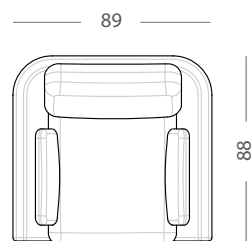
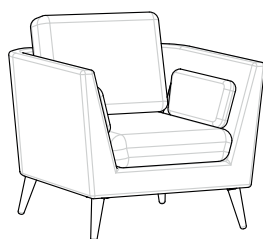

JANE

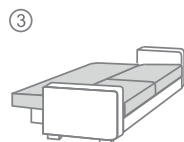
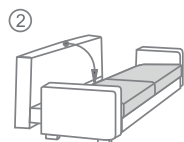
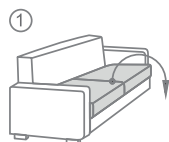

AUTOMAT DO
ROZKŁADANIA



POJEMNIK
NA POŚCIEL



SPRĘŻYNY
FALISTE



PASY
TAPICERSKIE



NOGI
WOSKOWANE



TKANINY OBICIOWE
DO WYBORU

3DL z funkcją spania

 kg  1.19m³

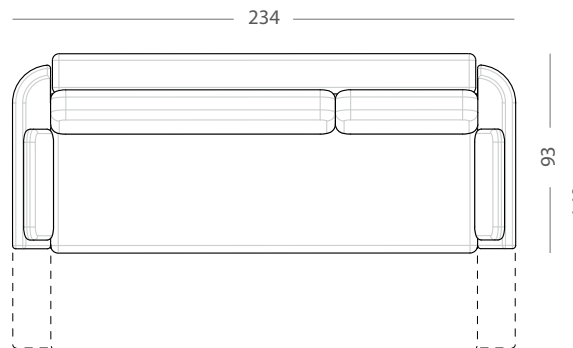
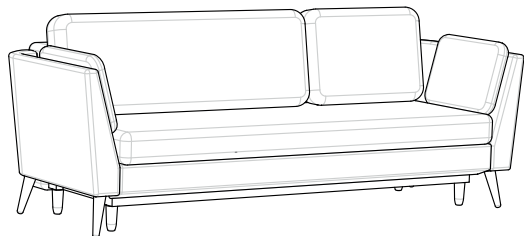

4 SOFA

2LM + 2RM

 kg  1.57m³

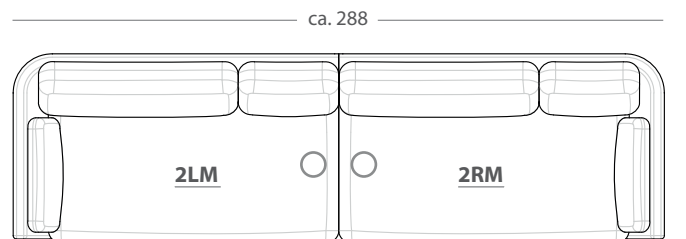
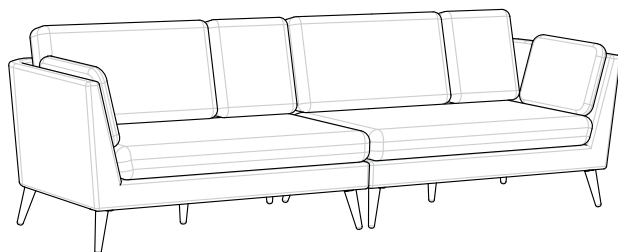

ŁAWKA  kg  0.11m³

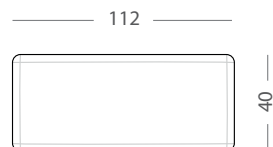

PUFA  kg  0.06m³

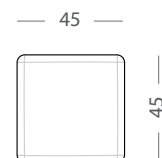

NAROŻNIK I LEWY (lub PRAWY) z funkcją spania

2LDL (lub 2RDL) + **3RMD** (lub 3LMD)

 kg  1.76m³

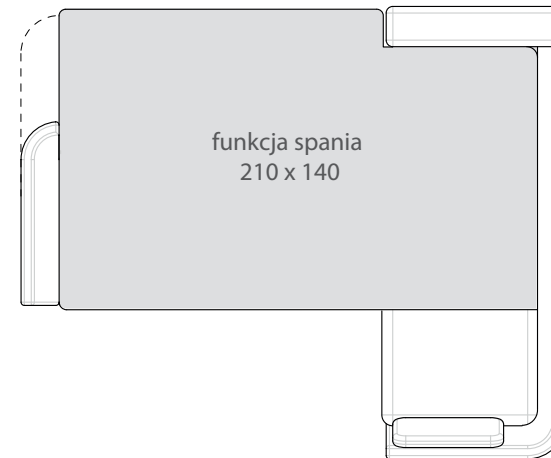
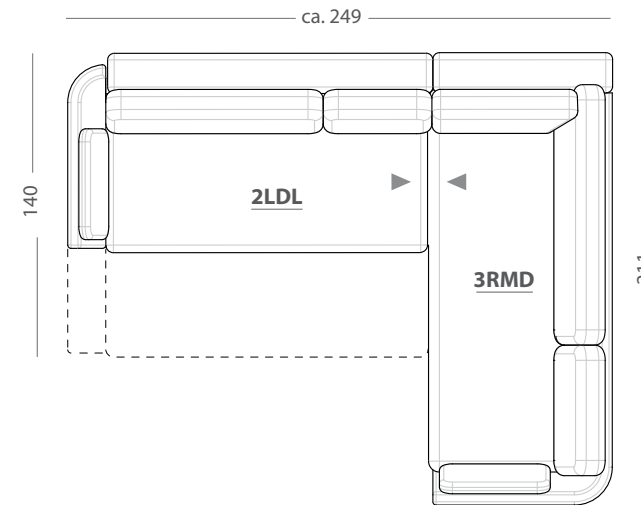
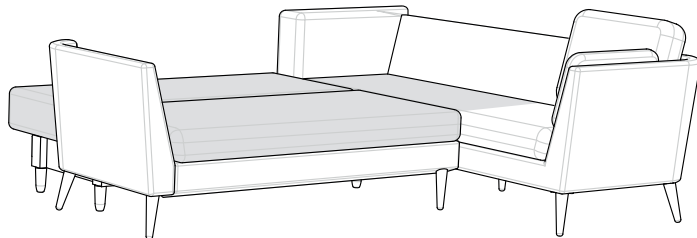
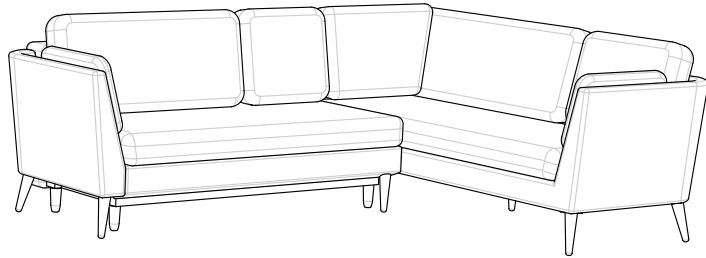

NAROŻNIK II

3LM + C + 3RM

 kg  2.71m³

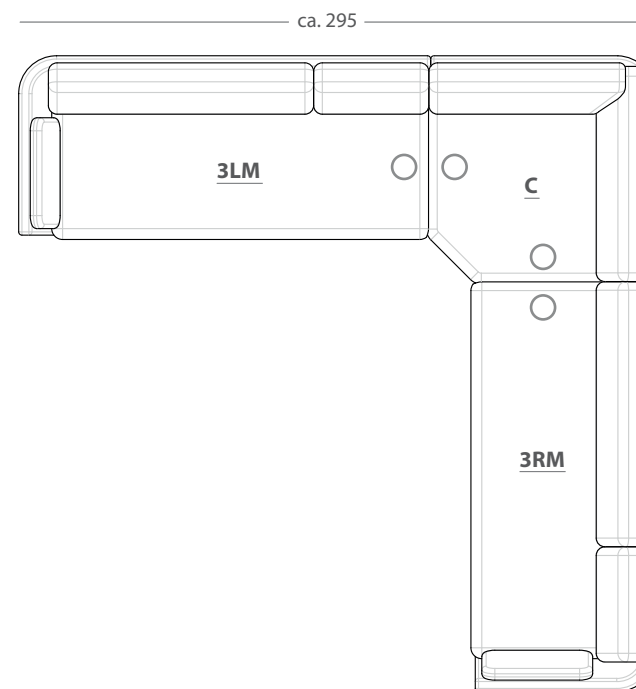
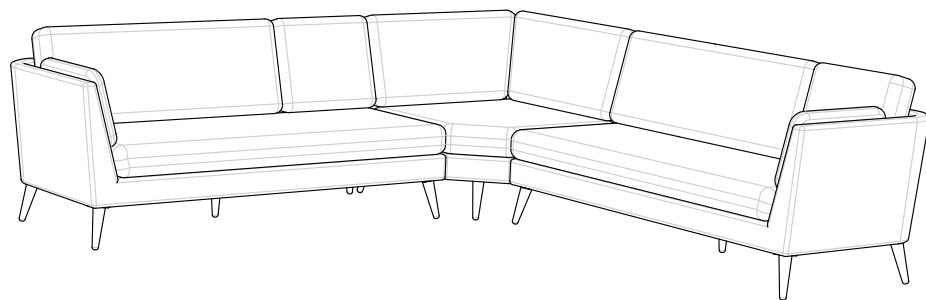

NAROŻNIK III LEWY (lub PRAWY)

3LM (lub 3RM) + C + 2RM (lub 2LM)

 kg  2.47m³

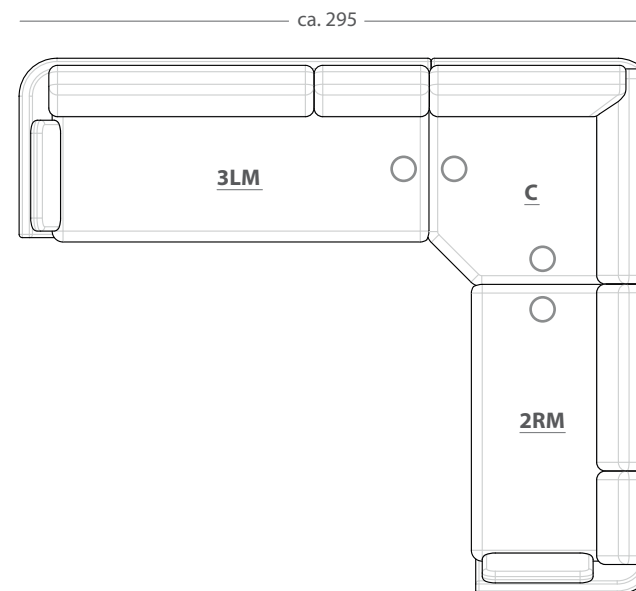
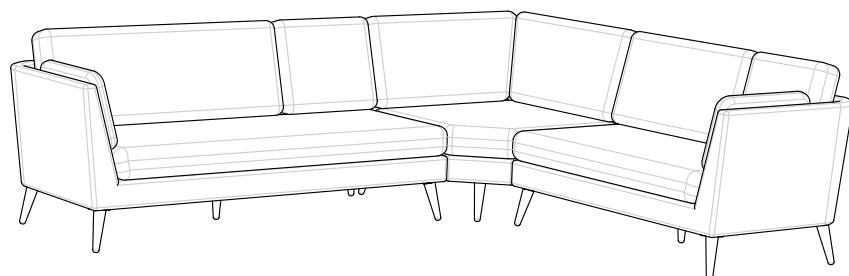

NAROŻNIK IV LEWY (lub PRAWY)

3LM (lub 3RM) + **3RS** (lub 3LS)

 kg  2.16m³

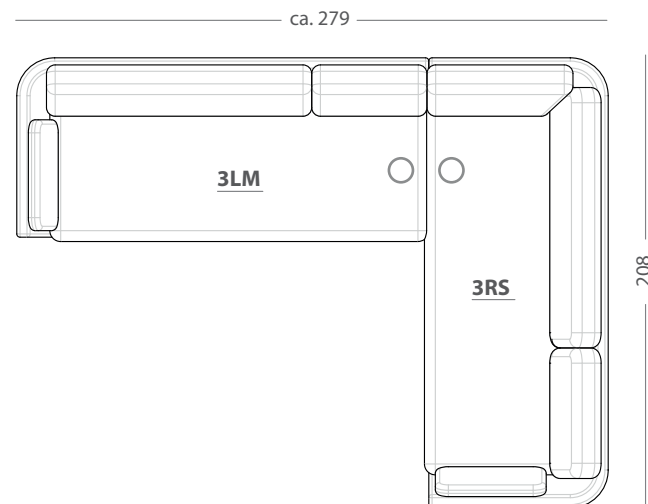
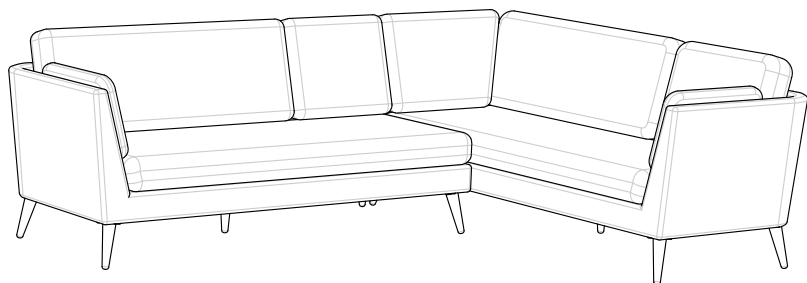

NAROŻNIK V LEWY (lub PRAWY)

2LM (lub 2RM) + **3RS** (lub 3LS)

 kg  1.92m³

